

Attention!

SAFETY INFORMATION, INSTALLATION, CARE AND MAINTENANCE INSTRUCTIONS. READ PRIOR TO ASSEMBLING AND USING THE PRODUCT.

Vuly cares about safety. Adult supervision is required at all times whilst equipment is in use.

Visit www.vulyplay.com/install for step by step video instructions, or scan this QR code:



PRE-INSTALLATION

WARNING!

You must attach your Cubby Swing **only** in the configurations shown below – to a **Medium** or **Large** swing set or play set configuration with capacity for two or three standard swings side by side.

You must not attach onto a Small swing set or play set (with capacity for only one standard swing).

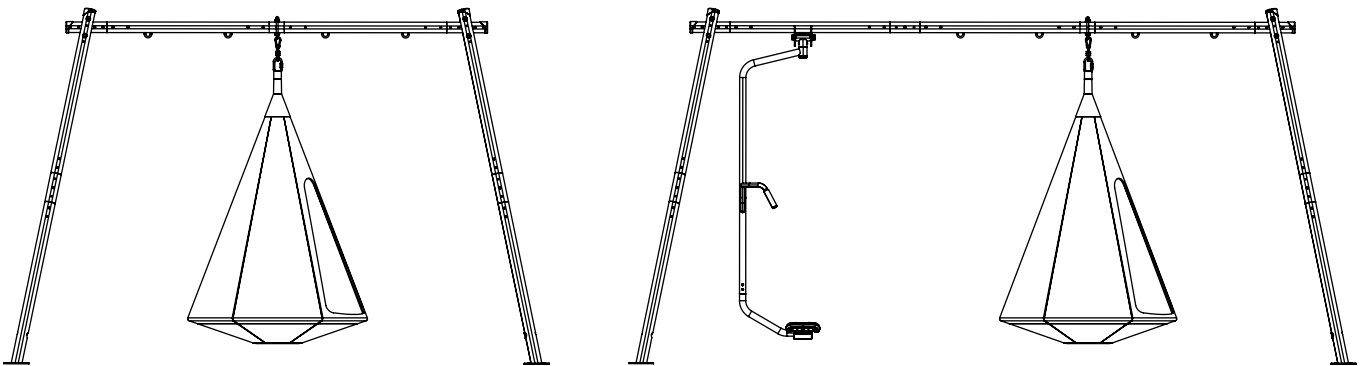

INSTALLATION

ATTENTION!

IF YOU HAVE A VULY QUEST MONKEY BAR, PLEASE GO TO STEP 6.

STEP | 1

Remove a Locking Bolt from the Rail Bracket and slip it over a Joiner on the Swing Rail.

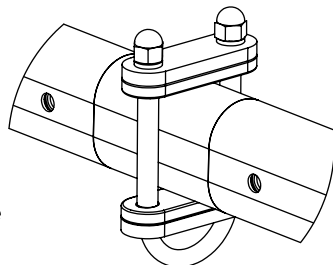

Reinsert the Locking Bolt and tighten the bolts firmly – until you notice the rubber beginning to squeeze – to secure the Rail Bracket.

STEP | 2

Unlock the smaller carabiner on your Cubby Swing, and hook it into the Rail Bracket.

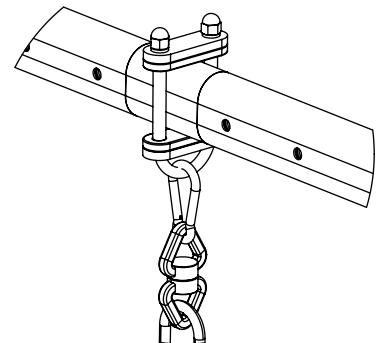

STEP | 3

Connect each Tube until you have created the full ring base.

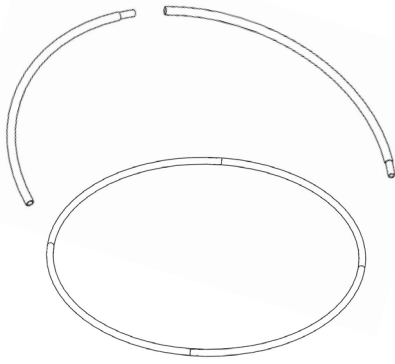

STEP | 5

Insert the Foam Padding into the Cubby Swing.

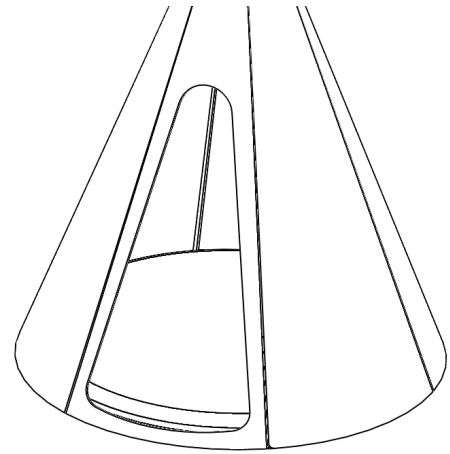

STEP | 4

Insert the completed ring into the base of your hanging Cubby Swing material. Go around the ring and secure it to the material inside with the attached Velcro straps.

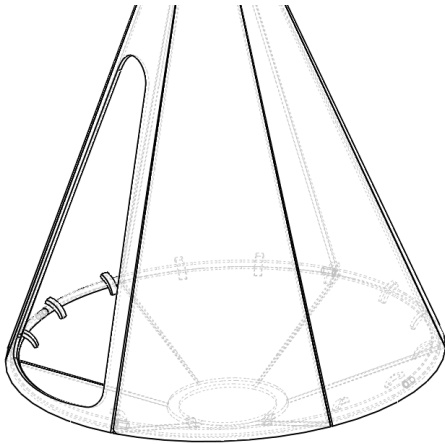

STEP | 6

To assemble on the Quest, please attach the smaller carabiner to the Accessory Joiners that are installed prior.

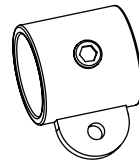

Use Accessory Joiner included in Box F.
Discard SINGLE HANGER

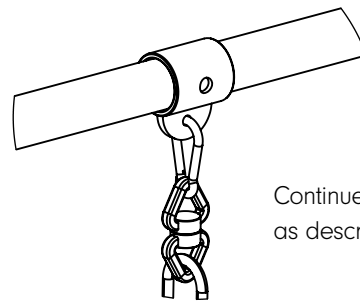

Continue to install the Cubby Swing as described in Step 3, 4 and 5.

CONGRATULATIONS!

You have attached your Cubby Swing to your Vuly Play Set.

DISCLAIMER

ATTENTION!

Safety information, installation and use instructions. Read prior to installing and using the swings.

See VulyPlay.com/support for any updates to these instructions.

WARNING!

- Minimum user age - 6 years. Only for domestic and outdoor use.
- Maximum user weight per swing station - 80 kg (175 lb) [65 kg (132 lb) on Spin Swing].
- Maximum combined user weight per swing set section - 150 kg (330 lb).
- Adult assembly required. Adult supervision required at all times.
- Ensure that the Swing Set is secured with anchors or bolts before use.



ADULT SUPERVISION IS REQUIRED AT ALL TIMES WHILST EQUIPMENT IS IN USE.
VULY CARES ABOUT SAFETY.